

TEMA:

Vistas - Normalización

3

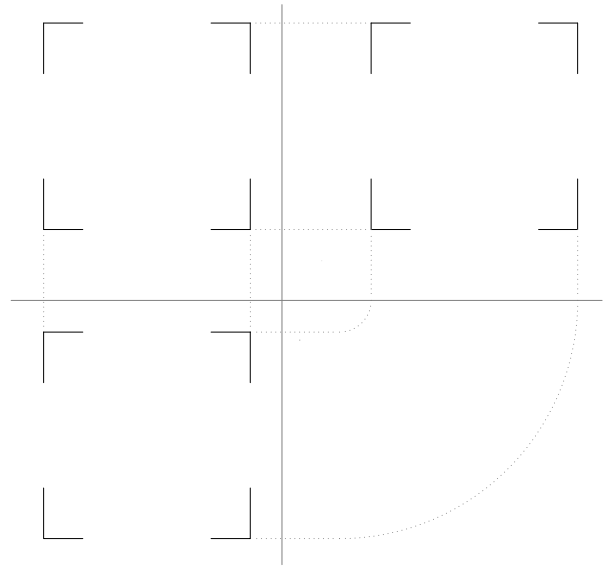
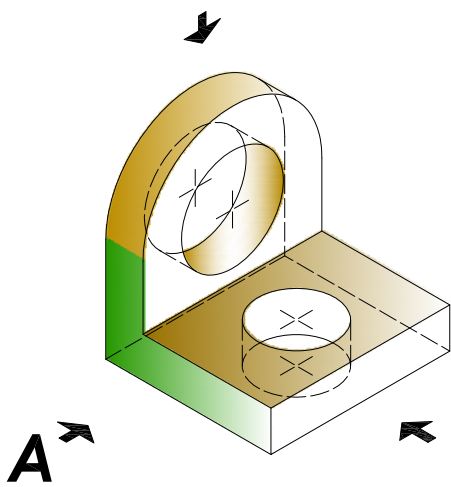
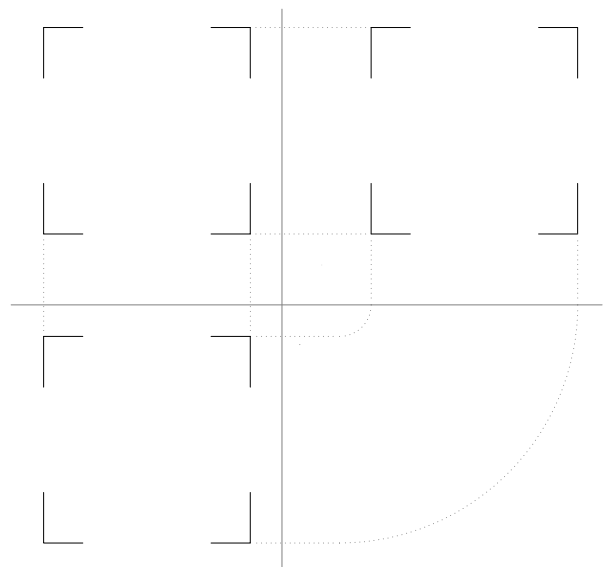
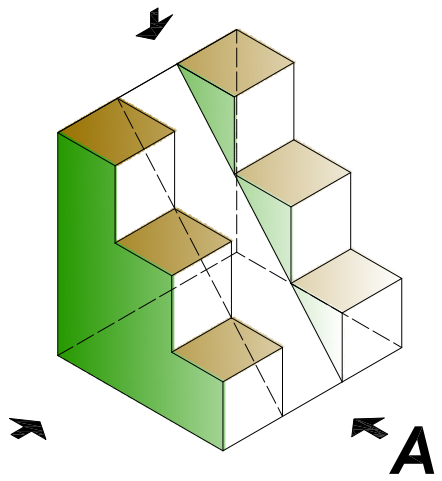
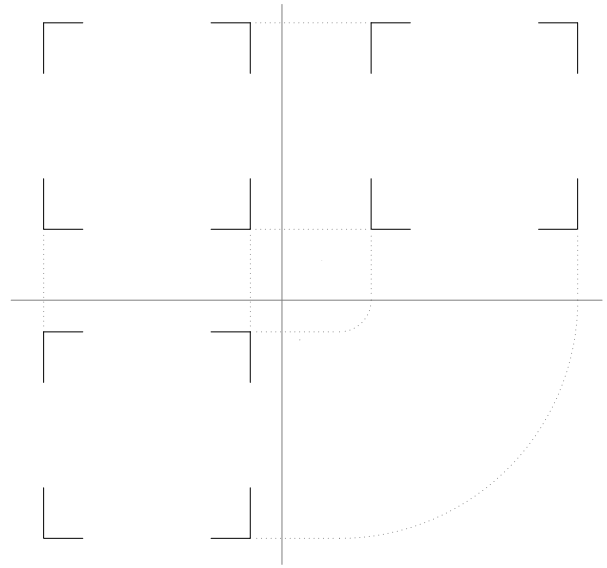
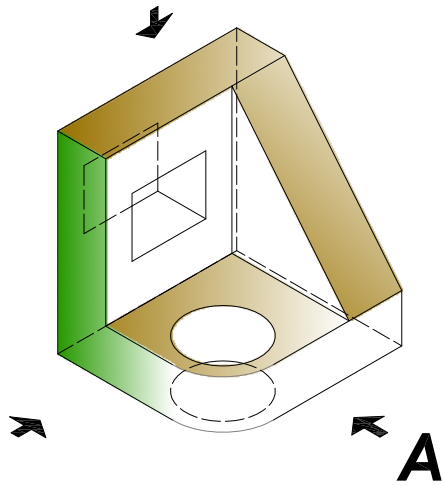

Croquizar las vistas de la pieza, proyecciones ortogonales, según el metodo del primer diedro ó sistema Europeo.

FECHA		APELLIDOS:	NOMBRE:	FIRMA
LÁMINA Nº		TITULACIÓN:	GRUPO:	